

Glass - Doors - Components

Table of Contents

STOCK PATTERN GLASS.....	PG. 3
DECORATIVE GLASS.....	PG. 5
FORGED ALUMINUM GRILLES.....	PG. 12
CRAFTSMAN DOOR GLASS.....	PG. 13
SPECIALTY DOOR GLASS.....	PG. 14
E-SERIES GLASS.....	PG. 17
M-SERIES GLASS.....	PG. 18
STOCK INSULATED GLASS.....	PG. 19
80" DOORS.....	PG. 20
96" DOORS.....	PG. 23
JAMB COMPONENTS.....	PG. 26
WARRANTY PAGE.....	PG. 27

Stock Pattern Glass

Baroque



1

Clear



2

Clear Low-E

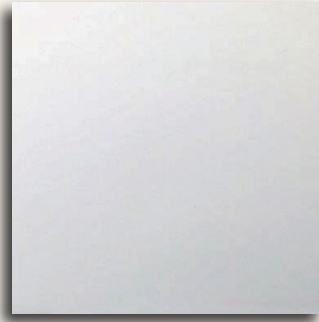

3

Cotswold



4

Digital

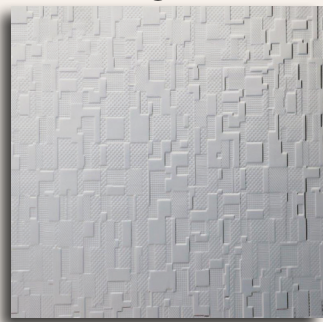

5

Everglade



6

Gluechip



7

Hammer



8

Mayflower



9

Minster

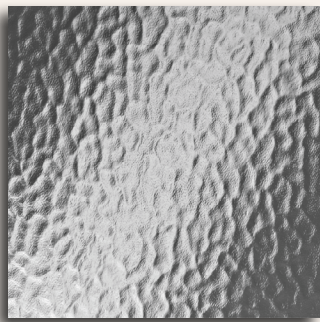

10

Rain



11

Satin



12

Seedy



13

Stippolyte (P. 62)



14

Sycamore



15

Taffeta



16

Stock Pattern Glass

Water



17

Flemish (China)



18

Flemish (Pilkington)



19

Granite



20

Double Granite



21

Reeded

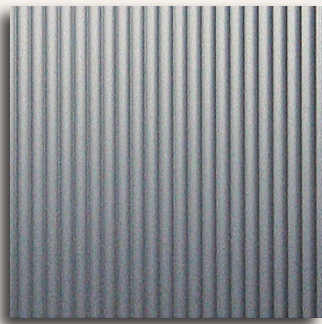

22

Small Reeded

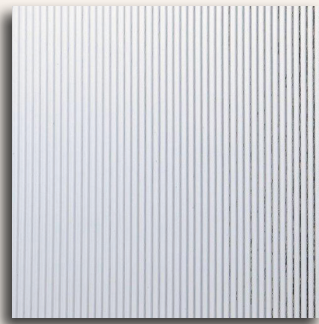

23

Glass Thickness

1/8"			
1			
2			
3			
7			
8			
12			
13			
17			
20			
21			
23			
	5/32"		
	4		
	5		
	6		
	9		
	10		
	11		
	14		
	15		
	16		
	18		
	19		
	22		
		3/16"	
		2	
		7	
			1/4"
			2
			7
			12

Decorative Glass

AD1



AD1-2167-Z/P
All Clear Bevel
or
All Glue Chip Bevel
21-1/2" X 67"



AD1-2156-AGC-Z/P
All Clear Bevel
or
All Glue Chip Bevel
21-1/2" X 56"

AD2



AD2-2167-Z/P
All Clear Bevel
or
All Glue Chip Bevel
21-1/2" X 67"



AD2-2156-AGC-Z/P
All Clear Bevel
or
All Glue Chip Bevel
21 1/2" X 56"

AD3



AD3-2167-Z/P
All Clear Bevel
or
All Clear and Glue Chip Bevel
21-1/2" X 67"

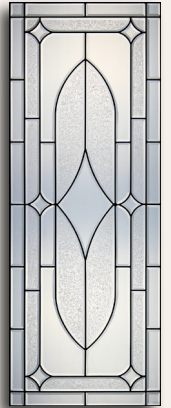

AD3-2156-GC-Z/P
All Clear and
Glue Chip Bevel
21-1/2" X 56"

AD13



AD13-2167-GC-Z/P
All Clear and
Glue Chip Bevel
21-1/2" X 67"

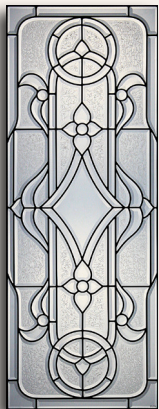

AD13-2156-GC-Z/P
All Clear and
Glue Chip Bevel
21-1/2" X 56"

AD20



AD20-2167-Z/P
All Clear and
Glue Chip Bevel
21-1/2" X 67"

AD30



AD30-2167-Z/P
Clear Bevel, Glue Chip,
& Water
21-1/2" X 67"



AD30-2156-Z/P
Clear Bevel, Glue Chip,
& Water
21-1/2" X 56"



AD30-1656 O-Z/P
All Clear and
Glue Chip Bevel
16-3/8" X 54-1/4"



AD30-2148R-Z/P
All Clear and
Glue Chip Bevel
21-1/2" X 47-3/4"

Decorative Glass

AD36



AD36-2167-Z/P
All Clear and
Glue Chip Bevel
21-1/2" X 67"

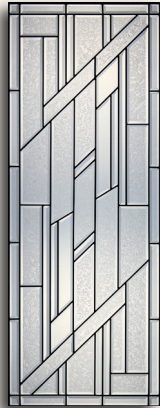

AD36-2156-Z/P
All Clear and
Glue Chip Bevel
21 1/2" X 56"

AD37



AD37-2167-Z/P
All Clear Bevel
21-1/2" X 67"

AD43



AD43-2156-Z/P
All Clear Bevel
21-1/2" X 56"

AD52



AD52-2156-Z/P
All Clear Bevel
21-1/2" X 56"

AD58



AD58-2156-GC-Z/P
All Clear and
Glue Chip Bevel
21-1/2" X 56"

AD65



AD65-2156-Z/P
Clear Bevel, Glue Chip,
& Water
21-1/2" X 56"

AD76



AD76-2156-Z/P
Clear Bevel, Water,
Clear, & Gluechip
21-1/2" X 56"



AD76-2148-Z/P
Clear Bevel, Water,
Clear, & Gluechip
21-1/2" X 47-3/4"



AD76-2148R-Z/P
Clear Bevel, Water,
Clear, & Gluechip
21-1/2" X 47-3/4"

AD84



AD84-2156-Z/P
Clear Bevel, Glue Chip,
& Clear
21-1/2" X 56"

Decorative Glass

AD87



AD87-1048-Z/P
Clear Bevel, Water,
& Double Granite
9-3/4" X 47-3/4"

AD89



AD89-1048-GC-Z/P
Clear Bevel and
Glue Chip
9-3/4" X 47-3/4"

AD97



AD97-1048-Z/P
Clear Bevel, Water,
& Glue Chip
9-3/4" X 47-3/4"

AD99



AD99-1048-Z/P
Clear Bevel, Glue Chip,
& Granite
9-3/4" X 47-3/4"

AD101



AD101-2136-Z/P
Clear Bevel and
Reeded
21-1/2" X 35-3/4"

AD104



AD104-2136-Z/P
Clear Bevel, Water,
& Reeded
21-1/2" X 35-3/4"

AD108



AD108-2136-Z/P
Clear Bevel, Glue Chip,
& Reeded
21-1/2" X 35-3/4"

AD110



AD110-2136-Z/P
Clear Bevel, Glue Chip,
& Water
21-1/2" X 35-3/4"

Decorative Glass

AD111



AD111-1636 O-Z/P
Clear Bevel, Glue Chip,
& Water
15-1/4" X 36-1/4"

AD116



AD116-1636 O-Z/P
Clear Bevel, Water,
& Glue Chip
15-1/4" X 36-1/4"

AD122



AD122-1636 O-Z/P
Clear Bevel, Baroque, &
Glue Chip
15-1/4" X 36-1/4"

AD200



AD200-2148-Z/P
Clear Bevel, Water,
and Clear
21-1/2" X 47-3/4"

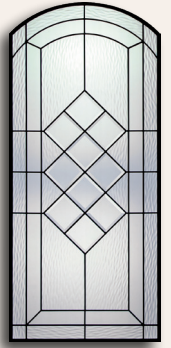

AD200-2148R-Z/P
Clear Bevel, Water,
and Clear
21-1/2" X 47-3/4"

AD201



AD201-2148R-Z/P
All Clear and
Glue Chip Bevel
21-1/2" X 47-3/4"

AD202



AD202-2148R-Z/P
All Clear and
Glue Chip Bevel
21-1/2" X 47-3/4"



AD202-1656 O-Z/P
All Clear and
Glue Chip Bevel
16-3/8" X 54-1/4"

AD203



AD203-2148R-Z/P
All Clear and
Glue Chip Bevel
21-1/2" X 47-3/4"

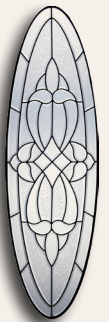

AD203-1656 O-Z/P
All Clear and
Glue Chip Bevel
16-3/8" X 54-1/4"



AD203-1048-Z
All Clear and
Glue Chip Bevel
9-3/4" X 47-3/4"

Decorative Glass

AD300



AD300 L GC-Z/P
All Glue Chip Bevel
21-1/2" X 67"

AD301



AD301 L GC-Z/P
All Clear and
Glue Chip Bevel
21-1/2" X 67"

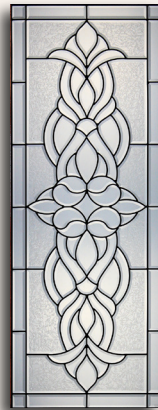

AD301 S GC-Z/P
All Clear and
Glue Chip Bevel
21-1/2" X 56"

AD303



AD303 L GC-Z/P
All Clear and
Glue Chip Bevel
21-1/2" X 67"



AD303 XS GC-Z/P
All Clear and
Glue Chip Bevel
21-1/2" X 47-3/4"

AD305



AD305 L GC-Z/P
All Clear and
Glue Chip Bevel
21-1/2" X 67"



AD305 S GC-Z/P
All Clear and
Glue Chip Bevel
21-1/2" X 56"



AD305 XS GC-Z/P
All Clear and
Glue Chip Bevel
21-1/2" X 47-3/4"

AD309



AD309 L GC-Z/P
All Clear and
Glue Chip Bevel
21-1/2" X 67"



AD309 S GC-Z/P
All Clear and
Glue Chip Bevel
21-1/2" X 56"



AD309 XS GC-Z/P
All Clear and
Glue Chip Bevel
21-1/2" X 47-3/4"

AD313



AD313 L GC-Z/P
All Clear and
Glue Chip Bevel
21-1/2" X 67"



AD313 S GC-Z/P
All Clear and
Glue Chip Bevel
21-1/2" X 56"



AD313 XS GC-Z/P
All Clear and
Glue Chip Bevel
21-1/2" X 47-3/4"

Decorative Glass

AD317



AD317 L GC-Z/P
All Glue Chip Bevel
21-1/2" X 67"

AD321



AD321 L GC-Z/P
All Clear and
Glue Chip Bevel
21-1/2" X 67"

AD324



AD324 L GC-Z/P
All Clear and
Glue Chip Bevel
21-1/2" X 67"

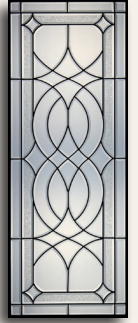

AD324 S GC-Z/P
All Clear and
Glue Chip Bevel
21-1/2" X 56"

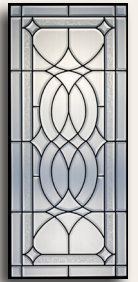

AD324 XS GC-Z/P
All Clear and
Glue Chip Bevel
21-1/2" X 47-3/4"

AD327



AD327 L GC-Z/P
All Clear and
Glue Chip Bevel
21-1/2" X 67"

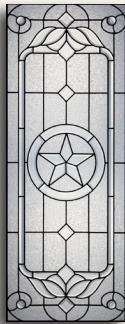

AD327 S GC-Z/P
All Clear and
Glue Chip Bevel
21-1/2" X 56"



AD327 XS GC-Z/P
All Clear and
Glue Chip Bevel
21-1/2" X 47-3/4"

AD801



AD801 L-Z/P
All Clear Bevel
or
All Glue Chip Bevel
21-1/2" X 67"



AD801 S-Z/P
All Clear Bevel
or
All Glue Chip Bevel
21-1/2" X 56"

AD901



AD901 L-Z/P
All Clear Bevel
or
All Glue Chip Bevel
21-1/2" X 67"

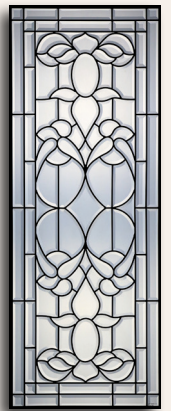

AD901 S-Z/P
All Clear Bevel
or
All Glue Chip Bevel
21-1/2" X 56"

Decorative Glass

AD402



AD402-2167-Z/P
Clear Bevel, Gluechip,
Baroque, Water,
and Granite
21-1/2" X 67"

AD408



AD408-2167-Z/P
Clear Bevel, Baroque,
Granite, and Reeded
21-1/2" X 67"

AD437



AD437-Z/P
Clear Bevel, Glue Chip,
and Water
23-1/8" X 11"

AD438



AD438-Z/P
Clear Bevel, Water,
and Gluechip
23-1/8" X 11"

AD440



AD440-Z/P
All Clear and
Glue Chip Bevel
23-1/8" X 11"

Forged Aluminum Grilles

AD606



AD606-2167 FA
21-1/2" X 67"



AD606-2156 FA
21-1/2" X 56"



AD606-2148R FA
21-1/2" X 47-3/4"

AD610



AD610-2156 FA
21-1/2" X 56"

AD623



AD623-2148R FA
21-1/2" X 47-3/4"

AD827



AD827-2167 FA
21-1/2" X 67"



AD827-2156 FA
21-1/2" X 56"

AD918



AD918 -2167 FA
21-1/2" X 67"

There are multiple glass options available with grilles. See Arlene's glass selection.

Craftsman Door Glass

AD22-11



AD8022-11-Z/P
Baroque and
Clear Bevel
7-1/8" X 10-3/4"

AD22-13



AD8022-13-Z/P
Clear Bevel and
Glue Chip
7-1/8" X 10-3/4"

AD22-CBLE



AD8022-CBLE
Clear Bevel Low-E
7-1/8" X 10-3/4"

AD22-11



AD9622-11-Z/P
Baroque and
Clear Bevel
7-1/8" X 7-1/8"

AD22-13



AD9622-13-Z/P
Clear Bevel and
Glue Chip
7-1/8" X 7-1/8"

AD22-CBLE



AD9622-CBLE
Clear Bevel Low-E
7-1/8" X 7-1/8"

Specialty Door Glass

AD23-16



AD8023-16-Z/P
Clear Bevel, Glue Chip Bevel,
Granite, and Reeded*

AD23-17



AD8023-17-Z/P
All Clear and
Glue Chip Bevel*

AD25-22



AD8025-22-Z/P
Clear Bevel and
Granite*

AD25-23



AD8025-23-Z/P
Clear Bevel and
Granite*

AD25-24



AD8025-24-Z/P
All Clear and
Glue Chip Bevel*

*Same glass fits in 96" (8/0) door. Please see page 25

Specialty Door Glass

AD26-27



AD8026-27-Z/P
All Clear and
Glue Chip Bevel

AD9626-27-Z/P
All Clear and
Glue Chip Bevel

AD26-28

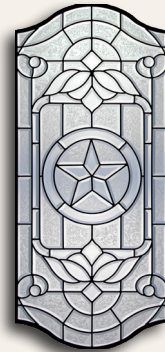

AD8026-28-Z/P
All Clear and
Glue Chip Bevel

AD9626-28-Z/P
All Clear and
Glue Chip Bevel

AD27-32



AD8027-32-Z/P
All Clear and
Glue Chip Bevel

AD9627-32-Z/P
All Clear and
Glue Chip Bevel

AD27-33

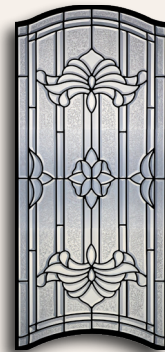

AD8027-33-Z/P
All Clear and
Glue Chip Bevel

AD9627-33-Z/P
All Clear and
Glue Chip Bevel

Specialty Door Glass

AD28-35



AD9628-35-Z/P
All Clear and
Glue Chip Bevel



AD8028-35-Z/P
All Clear and
Glue Chip Bevel

AD28-36



AD9628-36-Z/P
All Clear and
Glue Chip Bevel

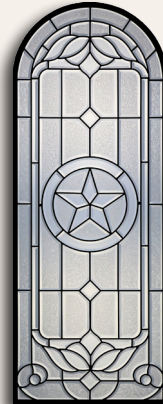

AD8028-36-Z/P
All Clear and
Glue Chip Bevel

AD29-38



AD9629-38-Z/P
All Clear and
Glue Chip Bevel



AD8029-38-Z/P
All Clear and
Glue Chip Bevel

AD29-41



AD9629-41-Z/P
All Clear and
Glue Chip Bevel



AD8029-41-Z/P
All Clear and
Glue Chip Bevel

E-Series Glass

E'E



E'E 56 GC-Z/P
All Clear and
Glue Chip Bevel
21-1/2" X 56"

E'E CB GC-Z/P
All Clear and
Glue Chip Bevel
21-1/2" X 67"

E108



E108-Z/P
All Clear Bevel
21-1/2" X 67"

E1103



E1103-Z/P
All Clear Bevel
or
All Glue Chip Bevel
21-1/2" X 67"



E1103 56-Z/P
All Clear Bevel
or
All Glue Chip Bevel
21-1/2" X 56"



E1103 48-Z/P
All Clear Bevel
or
All Glue Chip Bevel
21-1/2" X 47-3/4"

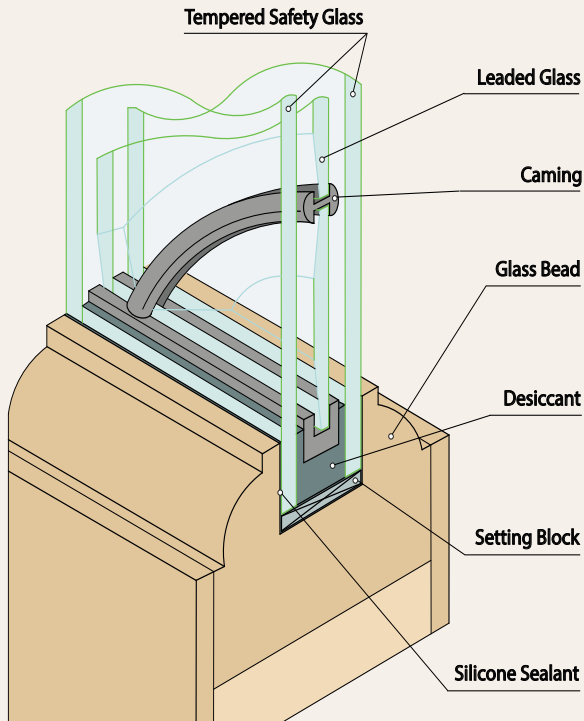

Cross Section of Insulated Leaded Glass

Caming Options

Caming is the H-shaped metal channels used in traditional hand-crafted leaded glass panel assembly.

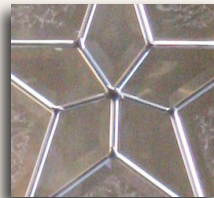

**Z: ZINC
(SILVER)**

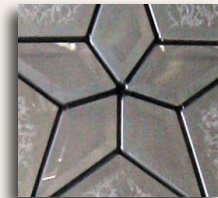

**P: PATINA
(BLACK)**

M-Series Glass

MTBD127



MTBD127R-Z/P
All Clear and
Glue Chip Bevel
21-1/2" X 67"



MTBD127R-Z/P
All Clear Bevel
21-1/2" X 47-3/4"

MTBD189



MTBD189L-Z/P
All Clear Bevel
21-1/2" X 67"



MTBD189XS-Z/P
All Clear and
Glue Chip Bevel
21-1/2" X 47-3/4"

MTDR17



MTDR17L-Z/P
All Glue Chip Bevel
21-1/2" X 67"

MTKBC1132



MTKBC1132L-Z/P
All Clear Bevel
21-1/2" X 67"

Stock Insulated Glass

Clear Low-E

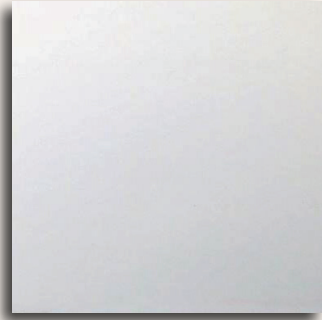

21-1/2" X 67" X 1/2"
 21-1/2" X 83" X 1/2"
 25-13/16" X 4-13/16" X 5/8"
 25-13/16" X 12-1/4" X 5/8"

Flemish (China)



21-1/2" X 47-3/4" Arch X 1/2"
 21-1/2" X 56" X 1/2"
 21-1/2" X 67" X 1/2"
 27-1/2" X 67" X 1/2"
 25-13/16" X 4-13/16" X 5/8"
 25-13/16" X 12-1/4" X 5/8"
 25-13/16" X 18-5/8" X 5/8"
 25-13/16" X 23-13/16" X 5/8"

Rain

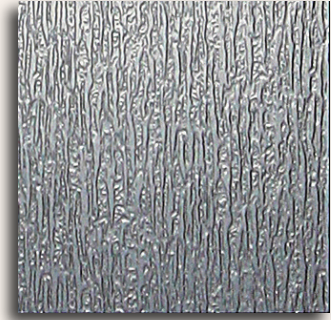

21-1/2" X 47-3/4" X 1/2"
 21-1/2" X 47-3/4" Arch X 1/2"
 21-1/2" X 56" X 1/2"
 21-1/2" X 67" X 1/2"
 27-1/2" X 67" X 1/2"
 25-13/16" X 4-13/16" X 5/8"
 25-13/16" X 12-1/4" X 5/8"
 25-13/16" X 18-5/8" X 5/8"
 25-13/16" X 23-13/16" X 5/8"

Reeded

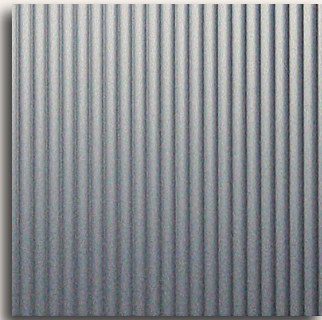

21-1/2" X 56" X 1/2"
 21-1/2" X 67" X 1/2"
 27-1/2" X 67" X 1/2"
 25-13/16" X 4-13/16" X 5/8"
 25-13/16" X 12-1/4" X 5/8"
 25-13/16" X 18-5/8" X 5/8"
 25-13/16" X 23-13/16" X 5/8"

Small Reeded

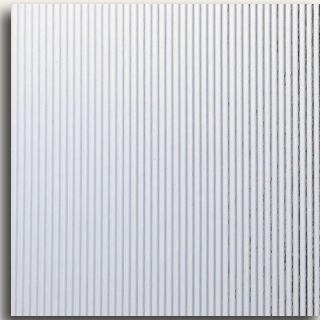

25-13/16" X 4-13/16" X 5/8"
 25-13/16" X 12-1/4" X 5/8"
 25-13/16" X 18-5/8" X 5/8"
 25-13/16" X 23-13/16" X 5/8"

**Sandblast
 w/ Clear Border**



25-13/16" X 4-13/16" X 5/8"
 25-13/16" X 12-1/4" X 5/8"

Satin

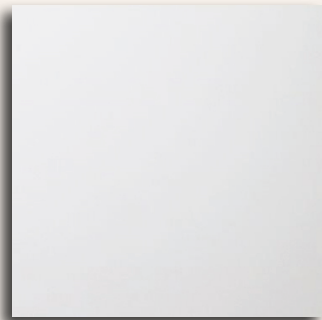

21-1/2" X 67" X 1/2"
 25-13/16" X 4-13/16" X 5/8"
 25-13/16" X 12-1/4" X 5/8"
 25-13/16" X 18-5/8" X 5/8"
 25-13/16" X 23-13/16" X 5/8"

Stippolyte (P. 62)



21-1/2" X 67" X 1/2"

Water



25-13/16" X 4-13/16" X 5/8"
 25-13/16" X 12-1/4" X 5/8"
 25-13/16" X 18-5/8" X 5/8"

80" Doors

Full Lite



3/4 Lite



2/3 Lite



Size	Part Number	Size	Part Number
24"	M2480-1567-0- (NRM)	12"	M681067-0 12 SL
30"	M3080-2167-0- (NRM)	14"	M681067-0 14 SL
32"	M3280-2167-0- (NRM)	16"	M681067-0 16 SL
36"	M682167-0 (NRM, RM, #2)		

Size	Part Number	Size	Part Number
32"	M3280-2156-1- (RM)	12"	M681056-1 12 SL
36"	M682156-1 (RM, #2)	14"	M681056-1 14 SL
42"	M4280-2756-1 (RM)	16"	M681056-1 16 SL

Size	Part Number	Size	Part Number
36"	M682148-2 (RM)	12"	M681048-1 12 SL
		14"	M681048-1 14 SL

2/3 Arch



2/3 Lite Twin



1/2 Lite



1/2 Lite Twin



Size	Part Number
36" Arch	M682148R-2 (RM, #2)

Size	Part Number
36" Twin	M681048-2

Size	Part Number	Size	Part Number
36"	M682136-2 (RM)	12"	M681036-1 12 SL
		14"	M681036-1 14 SL

Size	Part Number
36" Twin	M681036-2



NRM - No Raised Moulding

RM - Raised Moulding

#2 - Flat Raised Moulding

80" Doors

Full Oval



1/2 Oval



1/2 Oval Deluxe



Fan Lite



**Arch 2 Panel
V-Groove**



Size Part Number
36" Full M681656-0

Size Part Number
36" 1/2 M681636-2-RM

Size Part Number
36" 1/2 M681636-2-DXL

Size Part Number
36" M682311-4

Size Part Number
36" M3680AP2

Solid 6 Panel



3 Lite



4 Lite



5 Lite



TDL 15 Lite



Size Part Number
36" M68AP-6

Size Part Number
36" ME3680-3

Size Part Number
36" ME3680-4

Size Part Number
36" ME3680-5

Size Part Number
36" M3680-15LT
(Open, Low-E)



NRM - No Raised Moulding



RM - Raised Moulding

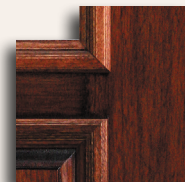

#2 - Flat Raised Moulding

80" Doors

Craftsman



Size 36"
Part Number M3680-22
 (Open, Low-E Bevel)

Royal



Size 36"
Part Number M3680-23

Cosmopolitan



Size 36"
Part Number M3680-25

Madison



Size 36"
Part Number M3680-26

Odessa



Size 36"
Part Number M3680-27

Presidio



Size 36"
Part Number M3680-28

Pinnacle



Size 36"
Part Number M3680-29



NRM - No Raised Moulding

RM - Raised Moulding

#2 - Flat Raised Moulding

96" Doors

Full Lite

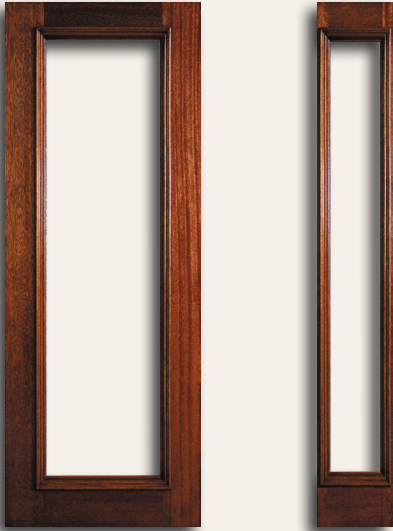

Size	Part Number	Size	Part Number
24"	M2496-1583-0- (NRM)	14"	M961083-0 14 SL
30"	M3096-2183-0- (NRM)		
32"	M3296-2183-0- (NRM)		
36"	M962183-0 (NRM, RM)		

3/4 Lite



Size	Part Number	Size	Part Number
30"	M3096-2167-1 (NRM)	12"	M961067-1 12 SL
32"	M3296-2167-1 (NRM)	14"	M961067-1 14 SL
36"	M962167-1 (NRM, RM)		
42"	M4296-2767-1 (RM)		

3/4 Arch



Size	Part Number
36" Arch	M962167-R-1

3/4 Oval Deluxe



2/3 Lite



2/3 Arch



1/2 Arch



Size	Part Number
36" 3/4	M961656-2-DXL
Opening fits full oval	

Size	Part Number	Size	Part Number
36"	M962156-2 (RM)	12"	M961056-1 12 SL
		14"	M961056-1 14 SL

Size	Part Number
36" Arch	M962156-R-2

Size	Part Number
36"	M962148-R-2



NRM - No Raised Moulding



RM - Raised Moulding



#2 - Flat Raised Moulding

96" Doors

**Arch 2 Panel
V-Groove**



Size 36"
Part Number M3696AP2

Solid 6 Panel



Size 36"
Part Number M96AP-6

TDL 6 Lite



Size 36"
Part Number M3696-1-6LT
(RM, NRM, Low-E NRM)

TDL 9 Lite



Size 36"
Part Number M3696-9LT
(Open, Glass Installed)

3 Lite



Size 36"
Part Number ME3696-3

5 Lite



Size 36"
Part Number ME3696-5
(Open, Satin IG)

6 Lite



Size 36"
Part Number ME3696-6
(Open, Satin IG)



NRM - No Raised Moulding



RM - Raised Moulding



#2 - Flat Raised Moulding

96" Doors

Craftsman



Size	Part Number
36"	M3696-22 (Open, Low-E Bevel)

Royal



Size	Part Number
36"	M3696-23

Cosmopolitan



Size	Part Number
36"	M3696-25

Madison



Size	Part Number
36"	M3696-26

Odessa



Size	Part Number
36"	M3696-27

Presidio

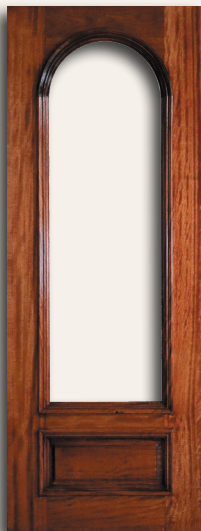

Size	Part Number
36"	M3696-28

Pinnacle



Size	Part Number
36"	M3696-29



NRM - No Raised Moulding

RM - Raised Moulding

#2 - Flat Raised Moulding

Jamb Components

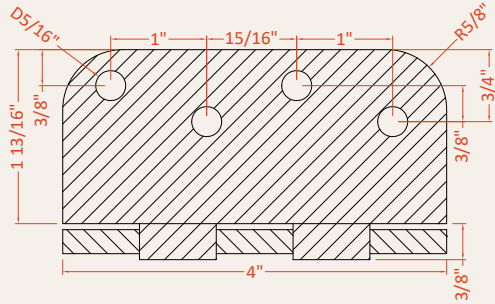

HBLK 4" X 4" Black Hinge - Non-removable
 HBLK-R 4" X 4" Black Hinge - Removeable
 HSLV 4" X 4" Silver Hinge - Non-removable
 HSLV-R 4" X 4" Silver Hinge - Removeable

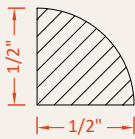

MQR105 1/2 105" Quarter Round - 1/2"

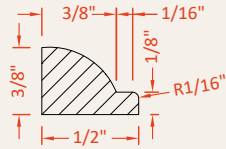

MGB105 105" Glass Bead

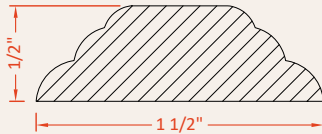

MIMC105 105" Inside Mullion Cap Moulding #2
 MIMC85 85" Inside Mullion Cap Moulding #2

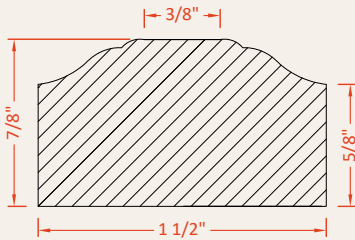

MOMC105 105" Outside Mullion Cap

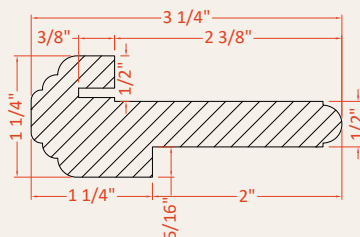

MTAST105 105" T-Astragal X 1/2"

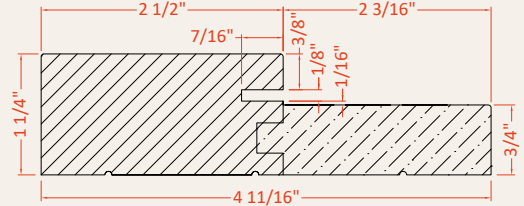

MJ4105 4-11/16" X 105" Jamb
 MJ485 4-11/16" X 85" Jamb

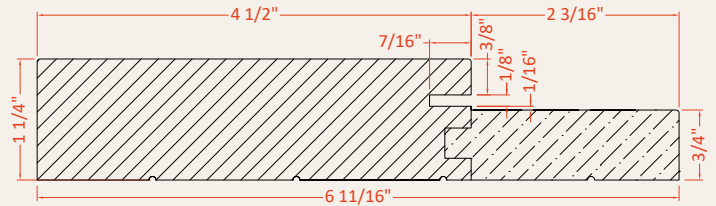

MJ6105 6-11/16" X 105" Jamb Leg
 MJ685 6-11/16" X 85" Jamb Leg

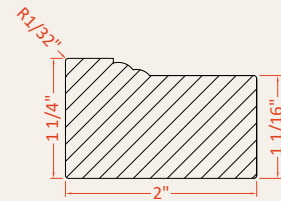

MMB105 105" Brickmould Mahogany

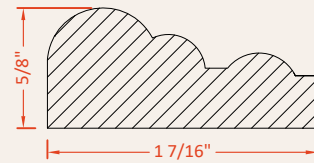

MM105 105" Inside Mullion Cap Moulding #1

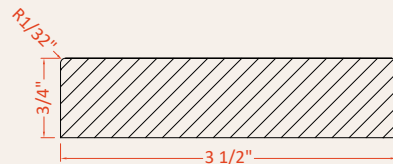

MS4S105 1" X 4" X 105"

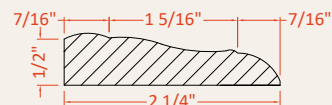

MCSG2105 2-1/4" X 105" Casing
 MCSG285 2-1/4" X 85" Casing

TERMS AND CONDITIONS, WARRANTY

1. "Arlene" refers to Arlene Stained Glass & Door Co., L.P. "Customer" refers to any person or entity purchasing a product directly from Arlene and not to any third party. "Arlene Design" refers to any unmodified design contained in Arlene's catalogs. "Customer Design" refers to either a design provided to Arlene by Customer, or a modification of an Arlene Design requested by Customer. Customer Designs will be so designated on the invoice that Arlene sends to Customer.
2. Arlene represents that Arlene owns all interests in and to or has the right to manufacture or have manufactured a product using an Arlene Design.
3. Arlene has no obligation to agree to make or sell any requested Customer Design unless Arlene has accepted the Customer's order for such Customer Design in writing. As a condition of acceptance of Customer's order by Arlene, Customer represents that Customer owns all interests in and to any Customer Design or has the right to authorize Arlene to manufacture or have manufactured a product using such Customer Design.
4. Customer shall indemnify Arlene, its subcontractors, and their respective directors and officers, against any and all claims, losses, liability, damages, costs, and expenses (including attorney's fees, expert witness fees, and court costs) directly or indirectly arising from or related to any actual or alleged infringement (including contributory infringement and inducement), misappropriation, or violation of any third party's patents, copyrights, trade secret rights, trademarks, or other intellectual property or proprietary rights of any nature in any jurisdiction in the world, resulting from the manufacture of a product using a Customer Design by or on behalf of Arlene.
5. Arlene shall indemnify Customer, its directors, and its officers, against any and all claims, losses, liability, damages, costs, and expenses (including attorney's fees, expert witness fees, and court costs) directly or indirectly arising from or related to any actual or alleged infringement (including contributory infringement and inducement), misappropriation, or violation of any third party's patents, copyrights, trade secret rights, trademarks, or other intellectual property or proprietary rights of any nature in any jurisdiction in the world, resulting from the manufacture of a product using an Arlene Design by or on behalf of Arlene.
6. Arlene warrants to Customer that for the period set forth below from the date of purchase from Arlene of the product identified in any invoice, and subject to the conditions and exclusions stated below, each product identified in such invoice will be free from defects in material and workmanship which would render the product unfit for normal and recommended use and service when installed in the continental United States. This warranty constitutes the sole and exclusive warranty offered by Arlene. The warranty is not transferable, and no dealer, distributor, or representative of Arlene has the authority to modify or expand this warranty. The warranty period set forth above shall extend as follows:
 - a) For double-insulated glass units sized between one and fifteen square feet: five years from the date of purchase from Arlene.
 - b) For double-insulated glass units sized greater than fifteen and up to twenty-five square feet: two years from the date of purchase from Arlene.
 - c) For leaded triple-insulated glass units between one and fifteen square feet: two years from the date of purchase from Arlene.
 - d) For leaded triple-insulated glass units greater than fifteen and up to twenty-five square feet: one year from the date of purchase from Arlene.

THE ABOVE WARRANTY EXCLUDES ANY GLASS UNIT SIZED GREATER THAN TWENTY-FIVE SQUARE FEET.

7. Arlene offers a limited warranty for one year on wood doors sized up to 36 x 96 from the original date of purchase. This warranty shall be void if the door has not been stored, installed, and maintained in a good workable manner. If the door is installed unfinished, the warranty is void unless the door is sealed within a 72-hour period. During this period, if the door is exposed to rain or any water infiltration, the warranty shall be void. (Please see the Arlene website for a complete listing of conditions not considered defects covered by the Arlene warranty.)
8. Customer shall return any product subject to a warranty claim to Arlene's factory at Customer's expense along with a copy of the original purchase order and the date it was purchased. If the product has been attached to or installed in material not purchased from Arlene (such as a door), then to qualify for the warranty, the product must be removed from the material it has been attached to or installed in and only the product itself originally purchased from Arlene should be returned to Arlene's factory at Customer's expense.
9. Arlene shall repair or replace the product at Arlene's sole discretion and shall ship the repaired or replaced item to Customer at Arlene's expense, with no charge to Customer.
10. Arlene shall inspect items returned under a warranty claim and shall have no obligation under the warranty for any item damaged by the Customer or any third party. Any claim under the warranty for products that are not received in good condition by Customer must be made by Customer within 48 hours of receipt of the product by Customer. If Arlene determines that a returned product does not qualify for the above warranty, Arlene shall charge Customer for any repairs necessary.
11. THE WARRANTY SET FORTH IN PARAGRAPHS 6-10 CONSTITUTES CUSTOMER'S SOLE AND EXCLUSIVE REMEDY UNDER ANY CLAIM OR THEORY OF LIABILITY. ARLENE MAKES NO OTHER EXPRESS OR IMPLIED REPRESENTATIONS OR WARRANTIES WITH RESPECT TO THE PRODUCT, THE DESIGN, AGAINST INFRINGEMENT, MERCHANTABILITY, FITNESS FOR ANY PARTICULAR PURPOSE, OR USE BY CUSTOMER. ARLENE FURNISHES THE ABOVE WARRANTY IN LIEU OF ALL OTHER WARRANTIES, EXPRESSED OR IMPLIED, INCLUDING THE WARRANTIES OF NON-INFRINGEMENT, MERCHANTABILITY AND FITNESS FOR A PARTICULAR PURPOSE.
12. ARLENE SHALL NOT BE LIABLE FOR CONSEQUENTIAL, INDIRECT, OR INCIDENTAL DAMAGES OF ANY NATURE INCLUDING, WITHOUT LIMITATION, LABOR COSTS OF ANY KIND ARISING FROM OR IN CONNECTION WITH AN ALLEGED BREACH OF ANY WARRANTY OR NEGLIGENCE ON THE PART OF ARLENE. IN NO EVENT SHALL ARLENE PAY FOR THE COST OF LABOR, INSTALLATION, REMOVAL, DISPOSAL, OR FINISHING OF A GLASS UNIT OR DOOR, OR FOR ANY OTHER COST RELATING TO THE REPLACEMENT OF A GLASS UNIT OR DOOR.



Please visit our showroom!

Showroom: (8:00am - 4:00pm) Monday - Friday

Shipping & Receiving: (7:30am - 4:30pm) Monday - Friday

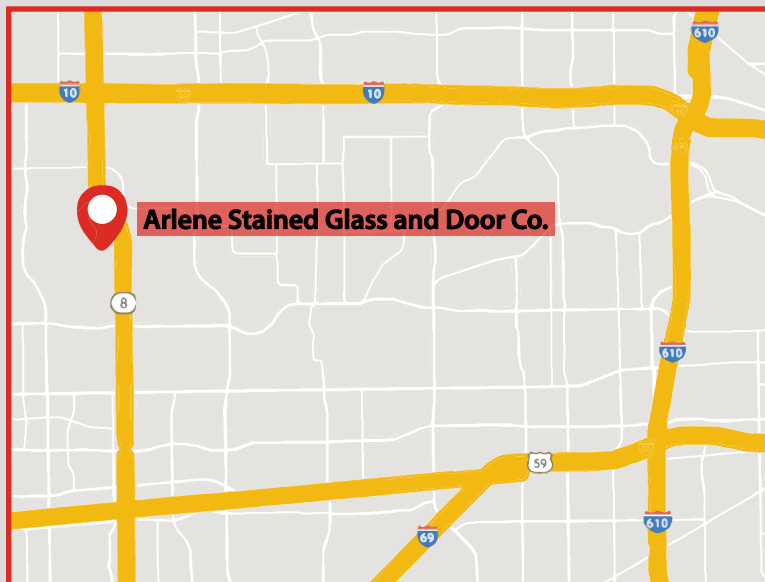

10440 Holly Springs Dr., Houston, TX 77042

Phone: 713-780-2497

Email: sales@arleneglassco.com

arlenestainedglassanddoor.com